

# Comfortable heat – every day



European-designed

Static and Dynamic

Nightstore Heaters

Design ■ Quality ■ Efficiency



# ASTRAL – A New Concept

Olsberg has been known for many decades as a recognised specialist in the field of electric heating.

An extensive product range of high-quality electrical heating systems has made them a leading supplier in both European and world markets.

The company's modern production methods and continuous development work have resulted in products that highlight the innovative technology and top-quality components featured in every Olsberg heating appliance.

Award-winning design, ease of installation, reliable quality, proven safety features and long life are convincing advantages shared by all Olsberg heaters.

High-quality components, coupled with skilled workmanship, are the hallmark of every Olsberg heater. A strict quality assurance system allows the company to manufacture to DIN EN ISO 9001:2000 standards, and certificates from international testing associations confirm product safety for all Olsberg nightstore heaters.



## **Astral – compact, attractive, functional**

The Olsberg range of Astral nightstore heaters will blend harmoniously into almost any domestic setting and, with the seven models that are available, will satisfy virtually every storage heating need.

Astral are static storage heaters - they give out heat via the surface and through natural convection, without the use of fans. This makes them ideal for areas such as dining rooms, entranceways, stairways and halls. All areas which need to be heated but where the room temperature is not critical.

Astral nightstore heaters are available with either manual or automatic charge regulators. With manual charge regulators, there is a choice of four models (0.85, 1.72, 2.55 and 3.4kW) and with automatic, the choice is three models (1.7, 2.55 and 3.4kW). The automatic version will regulate charge to approximately 90% of the room temperature, which provides energy saving.



*Simple, covered operating controls*



*Easy access for electrical connections*



*Top air-outlet grille for optimum heat*

THE NEW EUROPEAN STANDARD IN NIGHTSTORE HEATING

**Olsberg** 

# Best in Static Nightstore Heating with

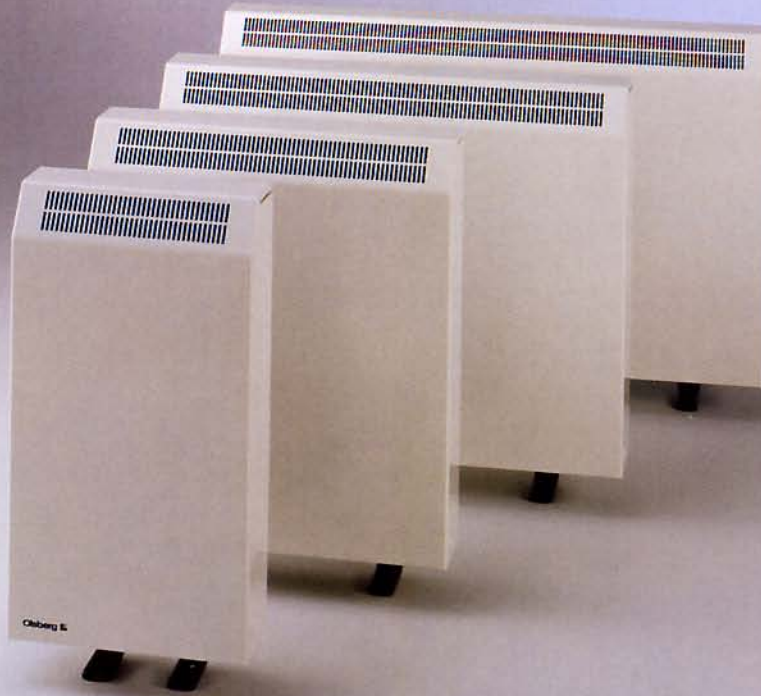

## The advantages of Astral

- ◆ Compact dimensions
- ◆ Attractive appealing design
- ◆ Simple functional controls
- ◆ Air outlet on top front panel for optimum distribution of warmth
- ◆ Specially-shaped convection chamber and special brick geometry gives even distribution of heat
- ◆ High quality thermal insulation
- ◆ Top quality components
- ◆ Conforms to local and international safety and quality standards
- ◆ Heater colour – pure white (RAL 9010) with graphite grey trim (RAL 7024)



### Simple heater assembly

- ◆ Slim cabinet form with compact dimensions
- ◆ Good looking attractive design
- ◆ Efficient thermal insulation made from Microtherm G, Vermiculite and mineral wool
- ◆ High quality, high density Feolite storage core
- ◆ Simple and clearly laid-out heater controls

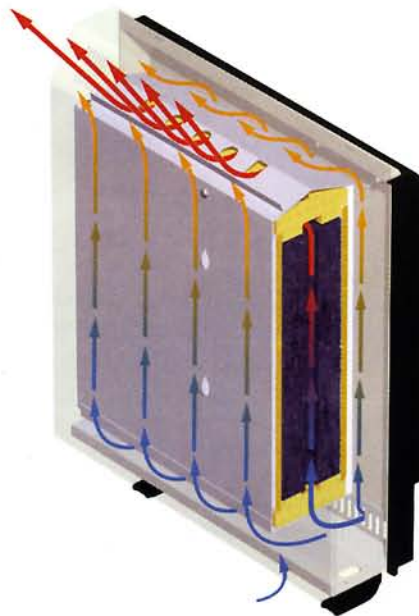

### Formed convection chamber

- ◆ Specially formed convection chamber across the entire core width with integral hot-air outlet and a special brick geometry for uniform core discharge
- ◆ Closed heating element conduits and air outlet openings with special thermal covering produce very low base temperatures, allowing electrical connection with standard cables



### Charge and discharge regulator

- ◆ High-efficiency bi-metal discharge regulator
- ◆ Capillary-tube charge regulator for an exact heater charge
- ◆ Automatic models have double capillary tube regulator to measure room temperature; 90% influence on heater charge
- ◆ Bi-metal high temperature safety regulator; automatic models have two regulators

THE NEW EUROPEAN STANDARD IN NIGHTSTORE HEATING



# th European-designed Technology

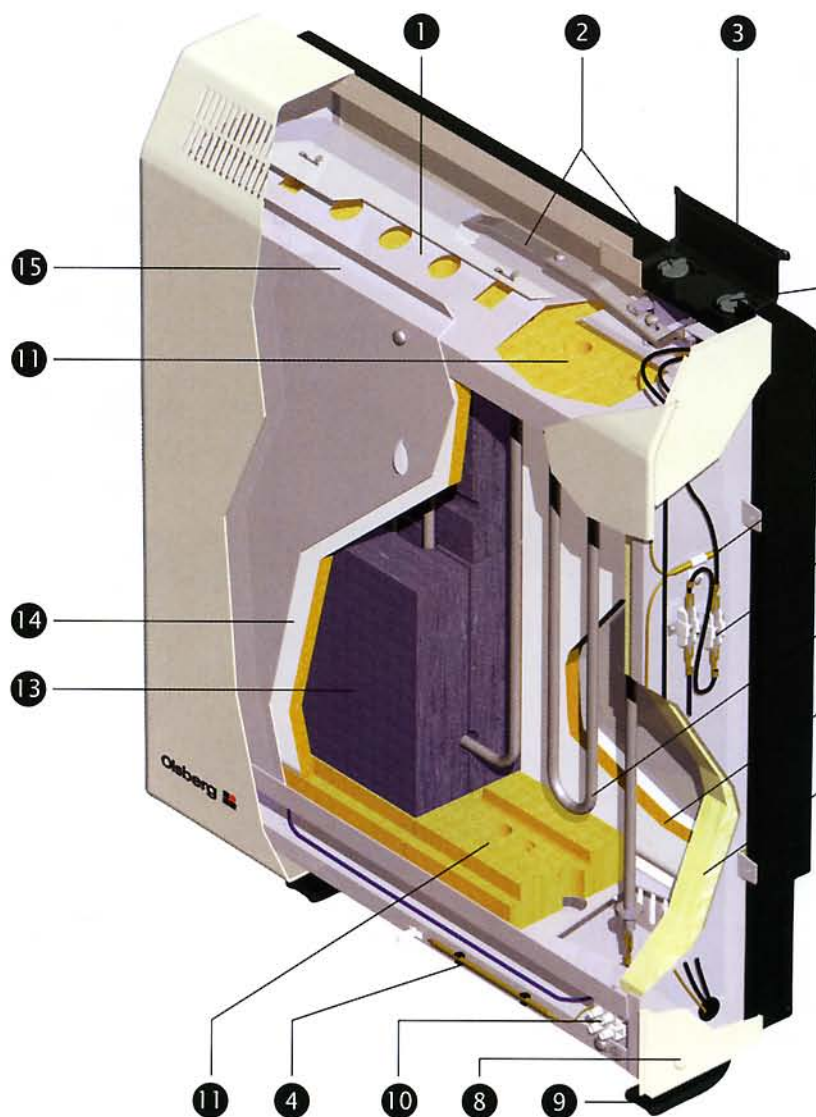

**Astral – state-of-the-art production methods and top quality components**

### Astral Specifications

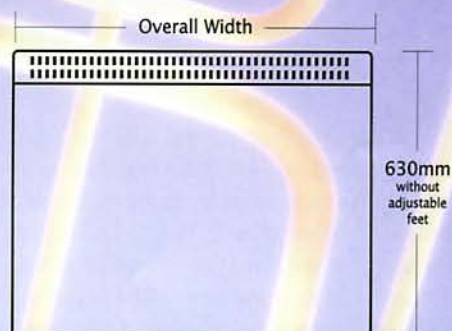

*Astral cut-away diagram*

- |   |  |
|---|--|
| <ul style="list-style-type: none"> <li>1 Specially formed convection chamber</li> <li>2 High efficiency bi-metal discharge regulator</li> <li>3 Cover plate for controls</li> <li>4 High quality capillary-tube charge regulator; automatic model with double capillary tube for additional room temperature measurement</li> <li>5 Bi-metal charge monitor, automatic with two safety cut-outs</li> <li>6 Two-layer thermal insulation at rear</li> <li>7 Mineral wool insulation</li> <li>8 Covered cabinet screws</li> </ul> | <ul style="list-style-type: none"> <li>9 Stable cabinet supporting feet</li> <li>10 Electrical connection terminals clearly laid out and easily accessible</li> <li>11 Vermiculite thermal insulation</li> <li>12 High quality Chrome Nickel heating elements</li> <li>13 Feolite storage core with special high core density</li> <li>14 Microtherm G thermal insulation</li> <li>15 One-piece cabinet front with cover plate and integral air-outlet grille</li> </ul> |
|---|--|

### Astral Static Nightstore Heater

Height without adjustable feet 630mm;  
feet height 70mm; depth 170mm  
Colour: RAL 9010 white; RAL 7024 grey trim

Model	Nominal Charge (kW)	Storage Capacity (kWh)	Overall Width (mm)	Heater Weight (kg)
<i>Manual</i>				
14/691-3	0.85	6.8	345	48
14/692-3	1.7	13.6	565	89
14/693-3	2.55	20.4	785	130
14/694-3	3.4	27.2	1005	171
<i>Automatic</i>				
14/692-4	1.7	13.6	565	89
14/693-4	2.55	20.4	785	130
14/694-4	3.4	27.2	1005	171

THE NEW EUROPEAN STANDARD IN NIGHTSTORE HEATING



# CARAT – Fan-assisted

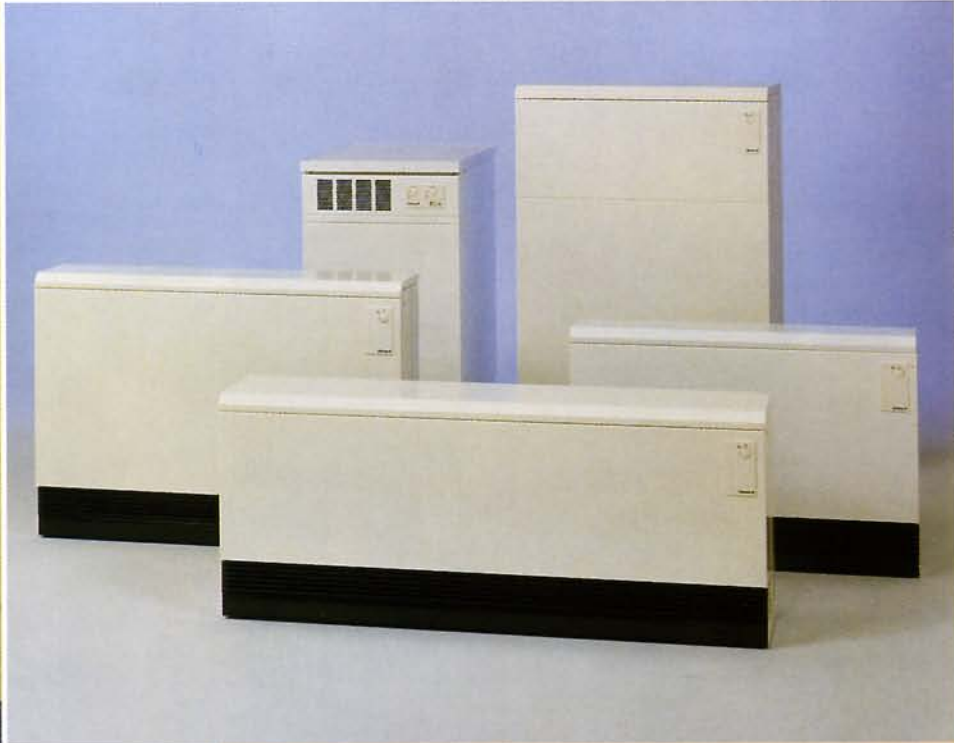

## Carat – intelligent dynamic technology providing more comfortable warmth

The Carat range of dynamic nightstore heaters by Olsberg feature high-end technology in an attractive, classical design - and within a compact space. They will provide comfortable warmth day in, day out to almost any living area.

Carat dynamic nightstore heaters emit heat via the surface of the appliance and also by means of the factory-fitted fan. The fan is regulated by a room thermostat which provides an exact room temperature. This fan can also be regulated by integral thermostat heater controls, which are available as optional accessories. They feature recessed operating switches with infinitely variable fan speed controls.

## The advantages of Carat

- ◆ Compact depth - only 270mm including integral wall-clearance grille
- ◆ Whisper-quiet radial fan
- ◆ Optimised thermal insulation with high grade insulating material
- ◆ Clearly laid-out functional controls
- ◆ Two-screw high speed fixing for easy installation and maintenance
- ◆ Accessible fluff filter for simple cleaning
- ◆ Heating elements in air channels for high speed heat dissipation
- ◆ Long-life heat-resistant stove enamelling
- ◆ Heater colour – pure white (RAL 9010) with graphite grey trim (RAL 7024)

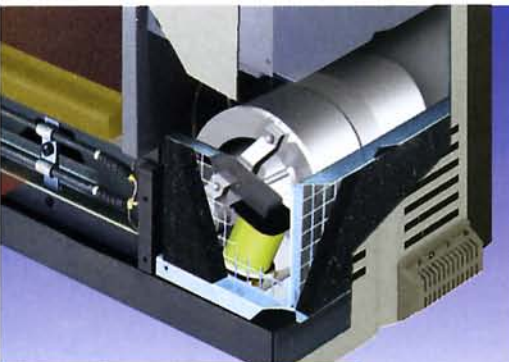

Whisper-quiet radial fan

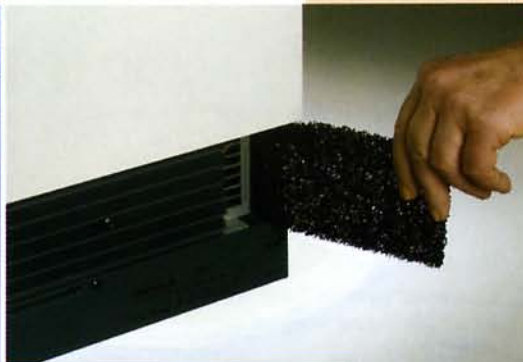

Easy maintenance fluff filter



Two screw high-speed installation

THE NEW EUROPEAN STANDARD IN NIGHTSTORE HEATING



# Dynamic Nightstore Heating

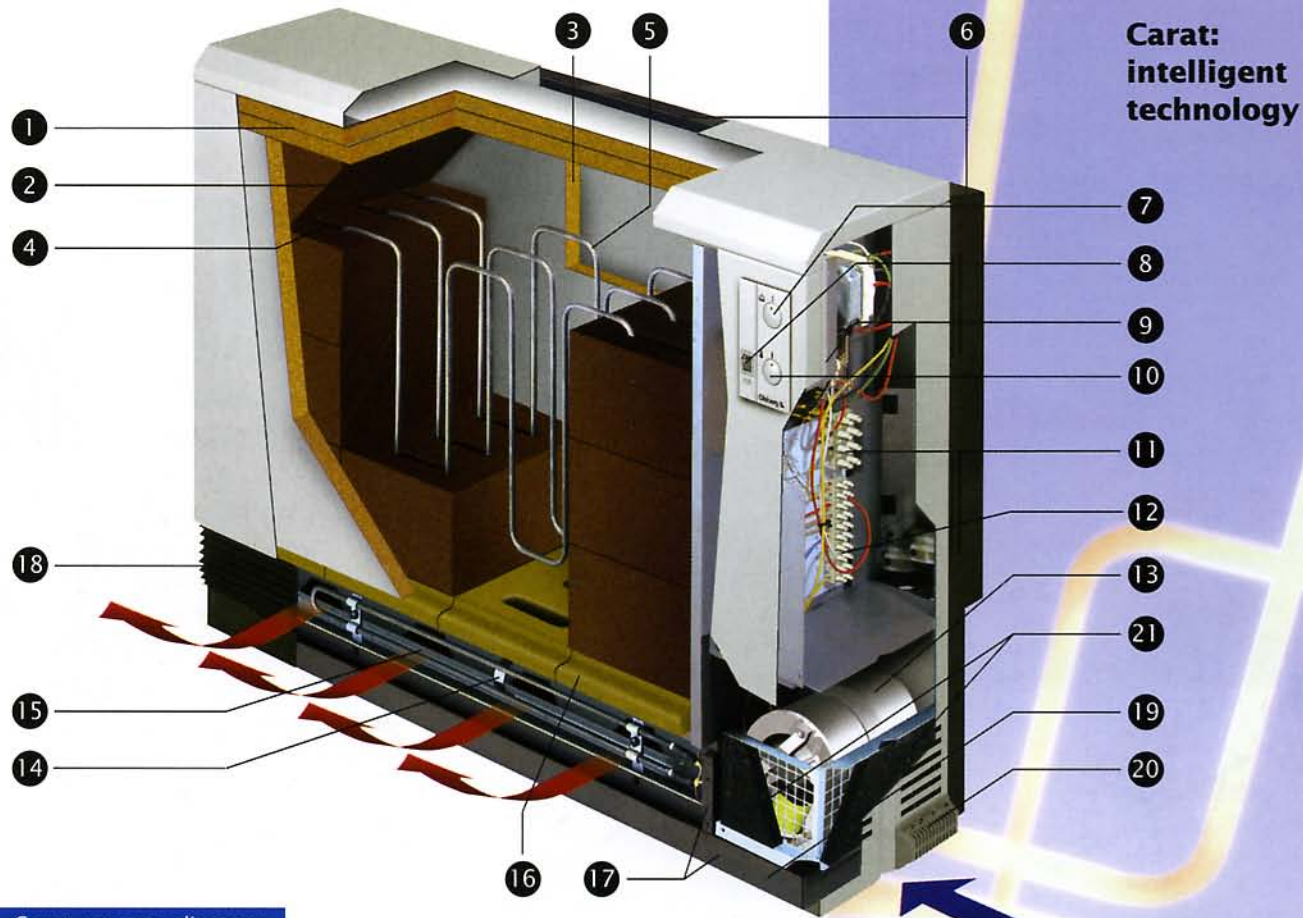

**Carat:  
intelligent  
technology**

*Carat cut-away diagram*

- |   |  |
|---|--|
| <p>1 Double-skinned insulation: Microtherm at top and sides, Multitherm at sides</p> <p>2 Storage core</p> <p>3 Microtherm insulation front and rear</p> <p>4 Air channel</p> <p>5 Sheathed heating element</p> <p>6 Grey setback rear panel with integral clearance grill</p> <p>7 Charge regulator with recessible operating knobs</p> <p>8 Day acting element switch</p> <p>9 High temperature safety cut-out</p> <p>10 Integral room thermostat with recessible operating knob (optional extra)</p> | <p>11 Heating element connecting strip, variable connection for different ratings</p> <p>12 Connecting terminal block</p> <p>13 Low noise radial fan</p> <p>14 Bi-metal with air-mixing plate; system optimised for outlet temperature &amp; noise</p> <p>15 Day acting element with safety cut-out (optional extra)</p> <p>16 Vermiculite insulation</p> <p>17 Stable plinth construction</p> <p>18 Moulded aluminium grille</p> <p>19 Base with moulded feet</p> <p>20 Room temperature sensor for integral room thermostat</p> <p>21 Fluff filter</p> |
|---|--|

## Carat Specifications

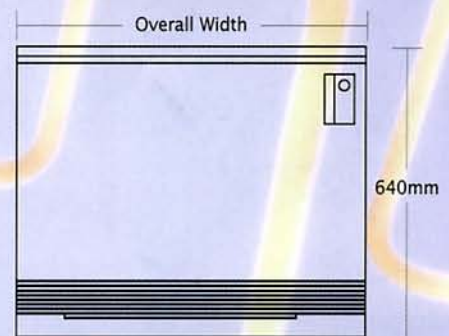

### Carat Dynamic Nightstore Heater

Height 640mm: depth 270mm

(including integral wall spacer)

Colour: RAL 9010 white; RAL 7024 grey trim

Model	Nominal Charge (kW)	Storage Capacity (kWh)	Overall Width (mm)	Weight approx. (kg)
14/512-3	1.7	16.0	575	100
14/513-3	2.5	24.0	750	140
14/514-3	3.3	32.0	925	180
14/515-3	4.2	40.0	1135	225
14/516-3	5.0	48.0	1310	265
14/517-3	5.8	56.0	1310	347

For further information, please contact:-

## **ENERSAVE**

**Enersave Products Ltd** P O Box 8867 Christchurch  
FreePhone 0800 508 509 Telephone 03 377 9450 Fax 03 377 9460  
info@enersave.co.nz www.enersave.co.nz